

Town of Friday Harbor
Water System
Sewer System
Extension Requirements

Town Hall
Friday Harbor,
San Juan County, Washington
Telephone: 378-2390

NOTE - Deposit funds in
Trust Account

Kramer, Chin & Mayo, Inc.
1917 First Avenue
Seattle, Washington 98101



STATE OF WASHINGTON
DEPARTMENT OF HEALTH

1511 Third Ave., Suite 719 • Seattle, Washington 98101-1632

Town of Friday Harbor

DEC 20 1991

RECEIVED

December 18, 1991

King Fitch
Town Administrator
Town of Friday Harbor
P.O. Box 219
Friday Harbor, Washington 98250

Subject: Town of Friday Harbor
San Juan County
Addendum to 1990 Comprehensive Water Plan

Dear King:

This Department has reviewed the Town's standard specifications for water mains and find them Satisfactory for inclusion in the system's Comprehensive Water Plan. Therefore, under current Washington Administrative code 246-290 the Town is not required to obtain individual project approval for distribution main extensions within the existing service area.

Sincerely,

Stephen S. Deem, P.E.
Regional Engineer
NW Drinking Water Operations

cc: San Juan County Health Department
Kramer, Chin & Mayo, Inc.

ORDINANCE NO. 868

AN ORDINANCE by the Town of Friday Harbor adopting by reference Water System Extension Requirements for construction of extensions to the Town of Friday Harbor water system and repealing Ordinances #390, #511, and #821 in their entirety.

BE IT ORDAINED by the Council of the Town of Friday Harbor;

SECTION 1. PURPOSE. That the purpose of this ordinance is to adopt by reference Water System Extension Requirements for construction of extensions to the Town of Friday Harbor water system and repeal Ordinances #390, #511, and #821 in their entirety.

SECTION 2. Section 13.08.010 of the Friday Harbor Municipal Code (FHMC) is hereby deleted and changed to read as follows:

"That the 'Town of Friday Harbor Water and Sewer System Extension Requirements' as published by the engineering firm of Kramer, Chin, & Mayo, Inc. is hereby adopted as the conditions and construction standards to be adhered to in any and all extensions to the Town of Friday Harbor water system."

SECTION 3. Section 13.08.020 of the FHMC is hereby deleted and changed to read as follows:

"The publication entitled 'Town of Friday Harbor Water and Sewer System Extension Requirements' shall be available for public review in the office of the Town Clerk."

SECTION 4. That Ordinances #390, #511, and #821 are hereby repealed in their entirety.

SECTION 5. That this ordinance shall become effective upon publication in accordance with State law.

ADOPTED this 19th day of March, 1992.

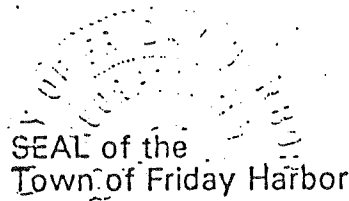

ATTEST:

Wendy J. Pichich
Wendy J. Pichich, Clerk Pro tem

H. James Cahail
H. James Cahail, Mayor

ORDINANCE NO. 867

AN ORDINANCE by the Town of Friday Harbor adopting by reference Sewer System Extension Requirements for construction of extensions to the Town of Friday Harbor sewer system and repealing Ordinances #362, #462, and #822 in their entirety.

BE IT ORDAINED by the Council of the Town of Friday Harbor;

SECTION 1. PURPOSE. That the purpose of this ordinance is to adopt by reference Sewer System Extension Requirements for construction of extensions to the Town of Friday Harbor sewer system and repeal Ordinances #362, #462, and #822 in their entirety.

SECTION 2. Section 13.24.010 of the Friday Harbor Municipal Code (FHMC) is hereby deleted and changed to read as follows:

"That the 'Town of Friday Harbor Water and Sewer System Extension Requirements' as published by the engineering firm of Kramer, Chin, & Mayo, Inc. is hereby adopted as the conditions and construction standards to be adhered to in any and all extensions to the Town of Friday Harbor sewer system."

SECTION 3. Section 13.24.020 of the FHMC is hereby deleted and changed to read as follows:

"The publication entitled 'Town of Friday Harbor Water and Sewer System Extension Requirements' shall be available for public review in the office of the Town Clerk."

SECTION 4. That Ordinances #362, #462, and #822 are hereby repealed in their entirety.

SECTION 5. That this ordinance shall become effective upon publication in accordance with State law.

ADOPTED this 19th day of March, 1992.

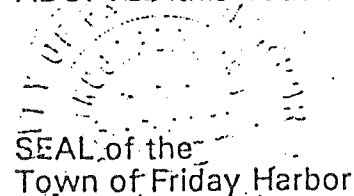

ATTEST:

Wendy A. Picinich
Wendy A. Picinich, Clerk Pro tem

H. James Cahail
H. James Cahail, Mayor

TABLE OF CONTENTS

<u>Section</u>		<u>Pages</u>
A	Checklist - Water System, Extension Checklist - Sewer System Extension Checklist - Storm Sewer System Extension	1 - 3
B	Application for Permission to Construct Extension	1 - 5
C	Design Requirements and Drafting Standards	1 - 3
D	General Conditions	1 - 8
E	Technical Specifications	1 - 10
F	Attachments:	
	Easement Form	
	Bill of Sale - Water System	
	Bill of Sale - Sewer System	
	Performance Bond	
	Water and/or Sewer Facility Contract	

SECTION A
CHECKLIST
WATER SYSTEM EXTENSION

Developer

<hr/> <p style="text-align: center;">Name of Extension</p>	<hr/> <p style="text-align: center;">Name</p> <hr/> <p style="text-align: center;">Address</p> <hr/> <p style="text-align: center;">Telephone</p>
--	---

A. Preliminary

- _____ 1. Application form completed (Developer)
- _____ 2. Extension fee paid (Developer)
- _____ 3. Application approved (Town)

B. Required before plans are started (where design if furnished by Town)

- _____ 1. Final plat (scale 1: - 100') (Developer)
- _____ 2. Contour map with 5' or less contour interval and scale of 1" = 100' (Developer)
- _____ 3. Road profiles (Developer)

C. Required before extension is constructed

- _____ 1. Plans, specifications, cost estimate, bill of sale forms approved by Engineer
- _____ 2. Approval of Contractor (Town)
- _____ 3. Cash bond (Contractor)
- _____ 4. Certificate of Insurance (Developer)
- _____ 5. Easements (Developer)
- _____ 6. Property boundary stakes in place (Developer)
- _____ 7. Material and equipment list approved by Engineer (Contractor)
- _____ 8. 48 hours' notice of starting date given to Town (Contractor)
- _____ 9. Construction stakes in place (Developer)

D. Required before any service is connected

- _____ 1. Applicable additional fees paid (Developer)
- _____ 2. Approval of construction (Engineer)
- _____ 3. Executed bill of sale delivered to Town (Developer)
- _____ 4. Acceptance of title (Town)

E. To be done one year after acceptance

- _____ 1. Final inspection (just prior to end of year (Town))
- _____ 2. Release of Performance Bond (Town)

**CHECKLIST
SEWER SYSTEM EXTENSION**

Developer

Name of Extension	Name
	Address
	Telephone

A. Preliminary

- _____ 1. Application form completed (Developer)
- _____ 2. Extension fee paid (Developer)
- _____ 3. Application approved (Town)

B. Required before plans are started (where design is furnished by Town)

- _____ 1. Final plat (scale 1" = 100') (Developer)
- _____ 2. Contour map with 5' or less contour interval and scale of 1" = 100' (Developer)
- _____ 3. Road profiles (Developer)

C. Required before extension is constructed

- _____ 1. Plans, specifications, cost estimate, bill of sale forms approved by Engineer
- _____ 2. Approval of Contractor (Town)
- _____ 3. Cash bond (Contractor)
- _____ 4. Certificate of Insurance (Developer)
- _____ 5. Easements (Developer)
- _____ 6. Property boundary stakes in place (Developer)
- _____ 7. Material and equipment list approved by Engineer (Contractor)
- _____ 8. 48 hours' notice of starting date given to Town (Contractor)
- _____ 9. Construction stakes in place (Developer)

D. Required before any service is connected

- _____ 1. Applicable additional fees paid (Developer)
- _____ 2. Approval of construction (Engineer)
- _____ 3. Executed bill of sale delivered to Town (Developer)
- _____ 4. Acceptance of title (Town)

E. To be done one year after acceptance

- _____ 1. Final inspection (just prior to end of year (Town))
- _____ 2. Release of Performance Bond (Town)

CHECKLIST
STORM SEWER SYSTEM EXTENSION

Developer

Name of Extension	Name
	Address
	Telephone _____

A. Preliminary

- _____ 1. Application form completed (Developer)
- _____ 2. Extension fee paid (Developer)
- _____ 3. Application approved (Town)

B. Required before plans are started (where design if furnished by Town)

- _____ 1. Final plat (scale 1: - 100') (Developer)
- _____ 2. Contour map with 5' or less contour interval and scale of 1" = 100' (Developer)
- _____ 3. Road profiles (Developer)

C. Required before extension is constructed

- _____ 1. Plans, specifications, cost estimate, bill of sale forms approved by Engineer
- _____ 2. Approval of Contractor (Town)
- _____ 3. Cash bond (Contractor)
- _____ 4. Certificate of Insurance (Developer)
- _____ 5. Easements (Developer)
- _____ 6. Property boundary stakes in place (Developer)
- _____ 7. Material and equipment list approved by Engineer (Contractor)
- _____ 8. 48 hours' notice of starting date given to Town (Contractor)
- _____ 9. Construction stakes in place (Developer)

D. Required before any service is connected

- _____ 1. Applicable additional fees paid (Developer)
- _____ 2. Approval of construction (Engineer)
- _____ 3. Executed bill of sale delivered to Town (Developer)
- _____ 4. Acceptance of title (Town)

E. To be done one year after acceptance

- _____ 1. Final inspection (just prior to end of year (Town)
- _____ 2. Release of Performance Bond (Town)

SECTION B

APPLICATION FOR PERMISSION TO CONSTRUCT EXTENSION TO THE FRIDAY HARBOR WATER SYSTEM AND/OR SEWER SYSTEM

The undersigned, hereafter referred to as "Developer," hereby makes application to the Town of Friday Harbor, San Juan County, Washington, for permission to construct and install an extension in the public right-of-way under the Town's franchise therefore, and/or on easements which are subject to approval of the Town, and to connect the the Town's water system and/or sewer system, and makes the following representations and agreements, to-wit:

1. LOCATION OF EXTENSION

The proposed extension will be installed in roads and/or easements and/or on the other approved rights-of-way and shall be for the use and benefit of the property hereafter described, which property is owned by the Developer and/or other persons who are contributing to the costs of said extension; that said other owners join in this application and are referred to as "additional owners;" that said property is described as follows:

2. DESCRIPTION OF EXTENSION

The proposed extension will consist of approximately _____ linear feet of water pipe and approximately _____ linear feet of sewer pipe and shall be installed in accordance with plans and specifications approved by the Town and in accordance with the Rules and Regulations of Construction Extensions adopted by the Town of Friday Harbor, which are on file in the Town Hall. The storm drainage system consists of approximately _____ linear feet of storm pipe.

3. EXTENSION FEE

An extension fee shall be paid by the Developer in consideration for the following basic work:

- a. Extension design (where requested or reviewed).
- b. Approving of contract plans, specifications, cost estimate, and bill of sale forms (where design is prepared by Developer).
- c. Submittal of contract plans and specifications to regulatory agencies for approval (if applicable).
- d. Application for State and/or County permits, where applicable.
- e. Inspection of the work as described in the General Conditions.
- f. Advice regarding the Town's requirements.

4. ADDITIONAL FEES

An additional fee shall be paid to the Town by the Developer for the following additional work:

- a. Additional inspections.
- b. Re-inspection of deficient work.
- c. Excessive water use.

5. PAYMENT OF FEES - DEPOSIT

The application fee shall be paid as follows:

- a. An amount equal to \$6,000 plus \$6.00 per linear foot for the estimated length of the water, storm and of the sewer extension shall be deposited with the Town at the time of filing of this application, said amount being \$_____.
- b. This fee may cover Town administration, engineering and inspection.
- c. The actual time and expense cost shall be deducted from this amount and the balance returned to the Developer prior to acceptance of the extension by the Town. If costs exceed the initial fee, the additional cost must be paid by the developer before the lines will be accepted by the Town.

6. PRELIMINARY ENGINEERING

Where design is not provided by the Town, the Developer shall furnish three copies of plans for review and approval.

The Developer shall also provide the description, location and elevation of all bench mark data available on the project site and this information shall be indicated on the plans.

7. EVIDENCE OF INSURANCE

Developer shall provide Town with written evidence of insurance covering public liability and property damage to third parties, in which the Town shall be named insureds, to the extent as provided in the General Conditions. Developer agrees to indemnify and hold Town harmless from any and all claims, demands, actions and/or liabilities of every kind and nature as may be made and/or entered against the Town by reason of or arising out of the acts of Developer, its agents, and/or contract, in making installation after obtaining the permission of the Town to proceed, including costs and attorney's fees incurred by the Town in investigating and defending against any such claim in the event of failure of Developer to so defend as herein required.

8. CASH BOND

Developer agrees to have any contractor installing an extension in accordance with this application and agreement to provide the cash specified in Section 5 on page B-2 prior to beginning construction of said extension and no construction shall be commenced until said bond is furnished. This cash bond shall be conditioned upon the contractor's strict compliance with the Town's conditions and standards contained herein and shall ensure the Town against any damage to the existing system as a result of the contractor's failure to comply.

The cash bond will be refunded to the contractor upon satisfactory completion of the extension and connection of the extension to the existing system. In the event of the contractor's failure to comply, the Town may exercise the right to irrevocably forfeit the total amount of the cash bond as liquidated damages. The amount refunded will be less the actual costs incurred by the Town.

A copy of the performance bond is attached to this set.

9. WARRANTY BOND OR CASH DEPOSIT

The Developer shall furnish to the Town upon completion of the project a certified cashier's check or warranty bond between Developer and the Town upon the form approved by Town and in an amount equal to 10 percent of the construction cost for a period of one year to ensure against faulty workmanship or materials. During the one-year warranty the Developer shall be liable for any expense caused by faulty workmanship or material. In case the Developer refuses to accept the responsibility, the Town shall use the cash or bond to cover all expenses and at the end of one year, the unused balance will be returned to the Developer.

10. EASEMENTS

Any required easement shall be obtained by Developer at his sole cost and expense, and a true copy of such easement shall be delivered to the Town prior to the time Developer commences construction hereunder. Upon completion of construction and prior to acceptance of said extension by Town in accordance with the provisions hereof, the original easement shall be delivered to the Town. The Developer shall provide all necessary easements at his sole cost regardless of changes in the Contract Plans.

11. PERMITS

All the necessary permits from any governmental agency shall be obtained by Developer directly or, if required, Town will obtain the same but at Developer's expense; and Town shall be provided with a copy of all such permits before construction commences.

12. GRADING OF ROADS

Developer shall grade all roads to the design subgrade elevation prior to the start of construction and shall advise the Town in writing of any changes which may be contemplated during construction. If the Developer changes the subgrade elevation of the road after completion of the extension, or any part thereof, the Developer shall be responsible for all costs incurred for the extension as a result of said change in subgrade elevation. This obligation shall remain in full force until San Juan County releases the right-of-way or road construction bond or bond of other description in connection with the Developer's obligation to the County for completion of roads within the area.

13. CONNECTION TO THE FRIDAY HARBOR SYSTEM

No less than 48 hours prior to the time that said extension is partially or fully completed and connection to the Town's system is desired, written application for permission to make the actual connection to the Town's system at a specified time shall be made by Developer or his contractor. All connections to the existing system shall require the authorization of the Town Administrator and shall be conducted in the presence of the Town.

During construction, the Developer's Contractor shall remove such water and debris accumulated in the extension under construction by pumping to suitable disposal areas and shall not be permitted to discharge such waste into the Town's existing facilities.

14. FINAL ACCEPTANCE

Developer's Engineer shall furnish the State Department of Health for water systems with a certified statement that installation was in accordance with approved plans and specifications.

Town agrees to accept title to the extension when all work which may in any way affect the lines constituting the extension has been completed and when any and all damage to said lines which may have been caused thereby has been repaired, and when the Town has made final inspection and given approval of the system as having been completed in accordance with the plans and specifications. Acceptance of said extension shall be by resolution of the Town Council.

Such acceptance by the Town shall not relieve Developer of the obligations to correct defects in labor and/or materials as heretofore provided and/or the obligations set forth in the applicable paragraphs hereof. Acceptance by the Town shall cause said extension to be the subject to the control, use and operation of the Town, which may apply thereto to all regulations and conditions of service and make such changes therefore as the Town deems reasonable and proper.

15. LIMITATION OF PERIOD FOR ACCEPTANCE

The extension shall be complete and accepted within one year of date of acceptance of this Application by Town. If the extension is not completed and accepted within one year from the date below, then the Developer's rights under this agreement shall cease and no additional service shall be connected to such extension unless and until Developer shall make a new Application or Town consents to the renewal of the existing Application and the Developer shall pay the additional administrative, legal, engineering and inspection costs involved, all as determined by the Town.

DATED at _____, Washington, this _____ day of _____, 19 ____.

Developer

Additional owners

Upon compliance with the terms and conditions of the contract documents furnished by the Town to the above named Developer, the Town of Friday Harbor will accept said extension and furnish water service thereto.

TOWN OF FRIDAY HARBOR
San Juan County, Washington

By _____
Mayor

Attest:

Town Clerk

SECTION C

DESIGN REQUIREMENTS AND DRAFTING STANDARDS

1. Design Requirements

The following design requirements are general in nature and are intended to assist the developer's engineer in preparing the extension plans. The Town may require modifications or additions to conform to the Comprehensive Plans, Department of Ecology or Department of Health requirements, or to meet specific site problems.

Water Mains

- Mains -
- Size: 8-inch minimum except 6-inch for cul-de-sacs in single-family residential zones supporting one fire hydrant and no possibility of extending main.
 - Material - Ductile-iron per AWWA C151, "CL.50 PVC per AWWA C900 DR 18, CL.150"
 - Location: 5-feet north or east of street centerline. Lines serving more than 20 lots or three fire hydrants must be looped.
 - Valves - Location: Valve at each connection to existing system. Typically intersections will have one less valve than pipe legs. At Town's option valves on all legs may be required. Commercial and multi-residential zones may have mid-block valves to separate fire hydrants.
- Fire Hydrants-
- Spacing: 400 feet maximum in single-family residential zones. In cul-de-sacs provide hydrant coverage equivalent to a block grid system. Typically a hydrant is set 150 feet from the center of the end lot in the cul-de-sac and a second hydrant is set 400 feet from the first.
 - 300 feet maximum in commercial and multi-family residential zones. Hydrants may be spaced closer if necessary to provide building coverage or to increase number of hydrants.

Service Lines - Size: 3/4-inch for single-family residence. One-inch for dual-residence line. Commercial and multi-family residence service will be sized by specific flow requirements.

Material: Copper Type K

Location: Preferably dual service at lot line. Alternate lot lines with side sewer locations.

Sanitary Sewers

Mains - Size: 8-inch

Slope: 0.005 minimum, uppermost run 0.008

Material: PVC per ASTM D 3034

Location: 5-feet south or west of street centerline

Manholes - Size: 48-inch

Spacing: 300 feet maximum

Material: Precast concrete

Side Sewers- Size: 6-inch

Slope: 0.020 minimum

Material: PVC per ASTM D 3034 SDR 35

Location: Preferably double service at lot lines. Use alternate lot line from water service location. If water and sewer service are at the same lot line, keep a 10-foot separation.

2. DRAFTING STANDARDS FOR SEWER AND WATER PLANS

- a. Plan sheets shall be Mylar 22-inch by 34-inch or 24-inch by 36-inch. Profile grid shall fit scales used. Scale shall be 1" = 50' horizontal and 1"=10' vertical.
- b. Base plan shall show street centerline, right-of-way lines, future curbs or edge of pavement and sidewalks. Other utilities to be constructed in the street shall be shown as necessary for plan checking. Use legend to identify various lines.

- c. Plans for sewer and water construction in existing streets shall show surface and underground improvements from topographic surveys and available records.
- d. Sewer plans shall show the sewer main, manholes, and side sewers. Line weight shall be sufficient to distinguish them from other facilities. Horizontal locations shall be indicated by stationing and offset from street centerline. Side sewers shall be stationed from lower manhole. Pipe size shall be indicated in inches, i.e., 8-inch S.
- e. Sewer profile shall show finished grade, manholes with inverts and top elevations and sewer line with pipe size, material, length between manhole centers and slope in feet per foot, i.e., 8-inch PVC - 296.8 feet S = 0.0064.
- f. Water plans shall show water main fittings, valves, fire hydrants, and services. Line weights shall be sufficient to distinguish them from other facilities. Horizontal location from street centerline shall be shown.

Water main size, material and length between angle points shall be shown, i.e., 8-inch PVC - 545 feet.

Describe hydrants, fittings, valves, etc. by number and joint type. Detail connection requirements. Typical plan callouts should be:

1 - 5" MVO	Fire Hydrant Assembly
1 - 8" x 6"	Tee M.J.
1 - 8"	Tee H. x Fl.
1 - 8"	Gate Valve M.J. x Fl

SECTION D

GENERAL CONDITIONS FOR JOBS CONSTRUCTED BY DEVELOPERS

1. SCOPE

These are general conditions to all contracts for extension of the Town's sewer and water system by Developers. Reference to, or requirements for, non-applicable conditions for any particular contract will be construed to have no meaning relative to the performance of such work.

2. DEFINITIONS

The following terms as used in this contract shall be defined and interpreted as follows:

- a. "Contract" or "This Contract:" The application for permission to construct an extension to the water distribution or sewer collection system executed by the Developer and the Town of which these general conditions are an integral part.
- b. "Town:" Town of Friday Harbor, San Juan County, Washington, acting through the Town Administrator, or his designee.
- c. "Developer:" The person, partnership, firm or corporation having an agreement with the Town to cause the installation of water system improvements to become a part of the Town water system upon completion and acceptance. The term shall also include the Developer's agents, employees and subcontractors. The legal address is shown in the application.
- d. "Town Engineer:" The Engineer for the Town of Friday Harbor. The Town Engineer may be the Town Administrator, or his duly authorized personnel, acting as agents for the Town in the administration of this contract, for the benefit of the Town in accordance with the Contract Documents.
- e. "Extension:" The system of water and/or sewer mains and appurtenances or other system improvements to be constructed in whole or in part through the performance of this Contract.
- f. "Plans:" The plans shall mean all official drawings or reproductions of drawings made or to be made pertaining to the work provided for in the Contract or to any structure connected therewith.
- g. "Specifications:" The specifications shall mean the technical specifications of this document.

- h. "Work:" The work necessary for the construction called for in the plans.
- i. "Words and Phrases:" Wherever the words "as directed," "as required," "as permitted," or words of like effect are used, it shall be understood that the direction, requirement or permission of the Town is intended. The words "approved," "acceptable," "satisfactory," and words of like import shall mean approval of or acceptable to the Town.
- j. "Surety:" Any firm or corporation executing a surety bond or bonds payable to the Town securing the performance of the contract either in whole or in part.

3. PLANS AND SPECIFICATIONS

The Developer shall retain an engineer to prepare plans and specifications for submittal to the Town for approval. The design must be prepared by a registered professional engineer licensed to practice in the State of Washington. The Developer may request that the Town prepare the plans. All costs incurred by the Town shall be borne by the Developer.

The design plans must be in accordance with construction standards of the Town and comply with all Town regulations, ordinances and State standards. Three sets of plans and specifications are to be submitted. When approved the Town will send one set of the Water Plan to the State Department of Health for approval.

Should the proposed improvement involve a pumping station, storage reservoir or other general facility, the Town reserves the right to do the engineering work, and prepare plans and specifications with all costs to be paid by the Developer.

4. PERMITS, LAWS AND REGULATIONS

- a. Permits, permission under franchises, licenses and bonds of a temporary nature necessary for and during the prosecution of the work, and inspection fees in connection therewith shall be secured and paid for by the Developer. Where the Town is required to secure such permits, permission under franchises, licenses and bonds and pay the fees, the costs incurred by the Town, thereby shall be reimbursed to the Town by the Developer.
- b. Developer shall give all notices and comply with all laws, ordinances, rules and regulations bearing on the conduct of the work required by the Contract Documents. If the Developer performs any work contrary to such laws, ordinances, rules and regulations, or prior to obtaining permits, permission under franchises, licenses and/or bonds as required to be furnished by or obtained by the Town, he does so at his own risk.

5. INSPECTION AND TESTS

- a. Inspection of the work by the Town and its authorized agents shall be strictly for the benefit of the Town and nothing contained herein shall be construed to relieve the Developer of his obligations under this application.
- b. The Town shall at all times have access to the work for the purpose of inspecting and testing. The Developer shall provide proper facilities for such access and for such inspection and testing.
- c. If any work should be covered up without approval or consent of the Town, it must be uncovered for inspection at the Developer's expense.
- d. The Developer shall make reasonable tests of the work at the Developer's expense upon the Engineer's request and shall maintain a record of such tests.
- e. For a performance test to be observed by the Town, the Developer shall make whatever preliminary tests are necessary to assure that the material and/or equipment are in accordance with the specifications.
- f. The Developer shall pay all costs of inspection and administration. The Town will determine the amount of inspection time necessary to ensure compliance with the plans and specifications.

6. RECORD DRAWINGS

Upon completion of the project the Developer's Engineer shall prepare an "as-built" reproducible together with two sets of drawings for the Town's use at no cost to the Town.

7. INSURANCE

The Developer shall carry liability and property damage insurance covering all work under this contract, including that done by subcontractors. This insurance shall name the Town and their Engineer as co-insured and shall be primary coverage with any insurance carried by the Town classified as additional coverage. Unless otherwise specified, this insurance shall be carried as follows: Bodily injury of not less than \$1,000,000 for bodily injury, including accidental death, to any person, and subject to that limit for each person, of not less than \$1,000,000 for each occurrence; and property damage of not less than \$500,000 for each occurrence.

8. MATERIAL AND EQUIPMENT

- a. Material and equipment shall be new. All materials and equipment furnished are warranted by the Developer as new and in accordance with the plans and specifications, if specified therein, and as suitable for

the intended purpose. The Developer shall furnish the Town with copies of the supplier's warranty and adopt the same as the warranty of the Developer and shall also be liable thereon to the Town.

- b. The Developer shall file three (3) copies of materials and equipment list with the Engineer prior to proceeding with construction. This list shall include the quantity, manufacturer, and model number of materials and equipment to be installed under the contract. This list will be checked by the Engineer as to conformity with the plans and specifications.

The Developer shall make any required corrections and file two (2) corrected copies with the Engineer. The Engineer's review and acceptance of the lists shall not relieve the Developer from responsibility for suitability for the intended purpose nor for deviations from the drawings and specifications unless the Developer has, in writing, called the Engineer's attention to such deviations at the time of submittal, and secured the Engineer's written approval for such deviation.

9. WORKMEN

- a. The Developer shall enforce strict discipline and good order among his employees and shall not employ on the work any person unfit or not skilled in the work assigned to him. Employees or agents of the Developer who, in the opinion of the Town, may impair the quality of the construction, shall be removed from the work.
- b. Necessary sanitation conveniences for the use of workmen on the job, properly secluded from public observation, shall be provided and maintained by the Developer.

10. DETERMINATION OF "OR EQUAL"

The Town shall be the sole judge of the question of "or equal" of any supplies or materials proposed by the Developer.

11. ROYALTIES AND PATENTS

The Developer shall be liable for all suits brought against the Town by reason of infringement of patent rights or license on any material, machine, appliance or process that he may use on the work or incorporate into the finished job except where specifically exempted by special provisions. The Developer shall defend and hold the Town harmless from any such suit, costs of defense and any judgment which may be made or entered against the Town thereon.

12. PROTECTION OF WORK AND PROPERTY AND SAFETY

- a. Developer shall continuously maintain adequate protection of the work from damage and shall protect Town's property from injury or loss arising in connection with or during the existence of this contract. He

shall make good any such damage, injury or loss, except as may be directly due to errors in the Contract Documents or caused by agents or employees of the Town. He shall adequately protect adjacent property from damage or loss occasioned by performance of the work. He shall provide and maintain all passageways, guard fences, lights and other facilities for protection required by public authority or local conditions.

- b. Developer shall bear the risk of loss or damage for all finished or partially finished work until the entire extension is accepted by the Town.
- c. Developer shall take all necessary precautions for the safety of employees on the work and shall comply with all applicable provisions of Federal, State and municipal safety laws.

13. EXISTING UTILITIES AND FACILITIES

- a. Underground utilities of record shall be shown on the construction plans insofar as it is possible to do so. These, however, are shown for convenience only and the Town assumes no responsibility for improper locations or failure to show utility locations on the construction plans.
- b. Developer shall take adequate precautions to protect existing lawns, trees and shrubs outside rights-of-way, sidewalks, curbs, pavements, utilities, adjoining property, and structures, and to avoid damage thereto. He shall, at his own expense, completely repair any damage thereto caused by his operations to the satisfaction of the Town, except as otherwise provided in other sections of these specifications.

14. REPLACING IMPROVEMENTS

Whenever it is necessary in the course of construction to remove or disturb culverts, driveways, roadways, pipelines, monuments, property stakes or other existing improvements, they shall be replaced to a condition equal to that existing before they were so removed and disturbed.

15. SUPERINTENDENCE AND SUPERVISION

Developer shall keep on the construction site during the progress of the work a competent superintendent and any necessary assistants, all satisfactory to the Town. The superintendent shall not be changed except with the consent of the Town. The superintendent shall represent Developer in his absence and all directions given to the superintendent shall be as binding as though given to Developer.

16. CONVEYANCE OF UTILITY TO THE TOWN

- a. A warranty bond minimum of \$5,000.00 or 10 percent of the construction cost, whichever is greater, shall be posted with the Town Clerk to ensure against any defect in any workmanship or material in

the project for a period of one (1) year. If desirable, this bond can be part of the performance bond.

- b. The Developer shall prepare a bill of sale to convey title to the Town for the utility improvement stating the same is free and clear of all encumbrances and that Developer has good and right authority to transfer title.
- c. The Developer, after acceptance of the completed water and sewer systems of the Town, shall have his Engineer prepare a certified statement that the extension was installed in accordance with the approved plans and specifications. The Town Engineer will submit this statement to the State Department of Health for water systems and the State Department of Ecology for sewer systems.

17. CORRECTION OF DEFECTS OCCURRING WITHIN WARRANTY PERIOD

When defects occurring within the warranty period are discovered, Developer shall start work to remedy any such defects within seven (7) days of mailing notice of discovery thereof by the Town and shall complete such work within a reasonable time. In emergencies, where damage may result from delay and where loss of service may result, corrections may be made by the Town immediately upon discovery, in which case the cost thereof shall be borne by the Developer. In the event the Developer does not commence and/or accomplish corrections within the time specified, the work shall be otherwise accomplished and the cost of same shall be paid by the Developer.

Developer shall be responsible for any expenses incurred by the Town resulting from defects in the Developer's work, including actual damages, cost of materials and labor expended by the Town in making emergency repairs and cost of engineering, inspection and supervision by the Town or Engineer, as well as reasonable attorney's fees to be fixed by the court in any action which the Town may commence against Developer to enforce the provisions hereof.

18. INDEMNITY

Developer shall indemnify, defend and save harmless the Town from and against all losses and claims, demands, payments, suits, actions, recoveries and judgments of every nature and description brought and recovered against the Town by reason of any act or omission of Developer, Developer's subcontractors, agents, and/or employees arising directly or indirectly from the performance of the contract or in guarding of the work. Developer will, after reasonable notice of any such suit or action, defend and pay the expense of defending any suit which may be commenced against the Town arising therefrom.

19. SUBLETTING AND SUBCONTRACTING

Developer agrees that he is fully responsible to the Town for the acts and omissions of subcontractors. Nothing contained in the Contract Documents shall create any contractual relation between any subcontractor and the Town.

20. SEPARATE CONTRACT; INTERFERENCE WITH OTHER DEVELOPERS

The Town reserves the right to perform work with its own forces or to let other contracts for work in connection with this project or other projects. Developer shall afford the Town and other contractors reasonable opportunity for the execution of their respective work and shall properly connect and coordinate his work with theirs.

21. LOSS OF SIDE SEWER MARKERS

The Town shall not be responsible for costs to locate sidesewers in the event of removal and destruction of side sewer markers by parties other than the Town itself.

22. QUALIFICATION OF CONSTRUCTION CONTRACTOR

All work shall be carried by Contractors experienced in the type of construction involved. The Town reserves the right to take necessary action to ascertain the competence and ability of proposed contractors. Contractors must be licensed by the State of Washington, and must have current Friday Harbor business license.

23. SURVEYS

All surveys including boundaries, topography for plans and profiles, and construction staking are the sole responsibility of the Developer. Surveys must be based on Town vertical datum. Where construction in Town rights of way outside of the development site occurs, the Town reserves the right to require additional surveys to establish right-of-way limits and to locate existing improvements as necessary to protect the Town's interests.

All surveys shall be carried out by a licensed Professional Land Surveyor.

24. TEMPORARY WATER POLLUTION CONTROL

Provide acceptable means to control erosion and turbid runoff from construction areas. Methods may include, but are not limited to, diversion of ditches or water courses, settling basins and filtration systems on drainage courses, or systems leaving the construction site.

25. TRAFFIC CONTROL AND PROTECTION OF PUBLIC

All work on public rights of way must conform to traffic control requirements of the Town including detours, signs, and flagmen. Maintain one-way traffic

as a minimum except when constructing street crossings. Restore two-way traffic at end of day.

At end of day all trenches must be backfilled or protected with lighted barricades to the satisfaction of the Town.

26. **COMPLETION TIME FOR WORK ON PUBLIC RIGHTS OF WAY**

Prior to construction on public rights of way, the Town will establish a reasonable completion time for the work including cleanup and restoration of improvements.

For overruns in completion time the Town will assess the Developer liquidated damages in the amount of \$50.00 per day.

SECTION E
TECHNICAL SPECIFICATIONS

1. MATERIALS

a. Water System

Mains

Pipe: Ductile iron (DI) conforming to AWWA C151, thickness Class 50, with push-on joints conforming to AWWA C111-90 and cement mortar lining conforming to AWWA C104 standard thickness.

Polyvinyl chloride (PVC) conforming to AWWA C900 DR18 (Class 150) cast-iron pipe equivalent O.D. with elastomeric gasket joints.

Fittings

Fitting joints for DI pipe and when specified on the plan for PVC pipe shall be mechanical joint (M.J.) conforming to AWWA Standard C111.

Fittings for PVC pipe when not specified M.J. on the plan may have push-on gasketed joints suitable for the pipe.

Flanges shall conform to Section 10.17 of AWWA C110.

Couplings

Flexible and flange by flexible couplings shall be Smith Blair or equal with gray iron sleeves and ductile-iron followers nuts and bolts.

Gate Valves

2 inches and smaller: Bronze, NRS wedge disc, standard square operating nut. Crane No. 438 or equal.

3 inch through 12 inch: Resilient seat per AWWA C509 non-rising stem, open CCW "O" ring stem seal, standard operating nut. Valve ends as indicated on the plans and conforming to fitting joints above.

Valve Box: Two-piece slide extension as shown on Water Standard Details herein.

Fire Hydrants

Conform to AWWA Standard C502 and the following requirements:

1. 3-foot 6-inch Bury unless otherwise specified on plan.
2. Two 2-1/2-inch hose nozzles NST.
3. One 5 1/4 -inch pumper nozzle NST.
4. 5 1/4 -inch main valve opening.
5. 6-inch flanged inlet connection.
6. Open counter clockwise.
7. Breakaway traffic flange.
8. "O" ring stem seal.
9. 1 1/4 " OPERATING NUT

Manufacturers: WATEROUS PACER, OR APPROVED EQUAL

Guard Posts

Reinforced concrete 9-inch diameter, 6-foot long.

Services

Saddles: Double-strap ductile-iron with corporation stop thread.

Corporation Stop: Bronze with AWWA C800 thread on inlet and flared copper outlet Ford Type F600 or equal.

Service Line Pipe: Copper tubing per ASTM B 88, Type K with flare-type joint fittings.

Curb Stop: Ford B22 or equal.

Line Setter: Ford 70 series Coppersetter or approved equal.

b. Gravity Sanitary Sewers

Pipe: Polyvinyl Chloride (PVC) conforming to ASTM D 3034 SDR 35 with joints conforming to ASTM D 3212 using restrained gaskets conforming to ASTM F 477.

Fittings: All fittings shall be PVC with gasketed joints compatible with PVC pipe.

Manholes: Precast concrete conforming to ASTM C 478 and the Sewer General Standard Details herein. Seal joints between precast elements with rubber gaskets. Provide PVC gasketed sewer manhole adaptor (sand collar) to connect PVC pipe to manhole.

Castings: Manhole frame and cover shall be gray iron conforming to ASTM A 48, Class 30. Machine frame and cover to provide non-rocking seat. Cover pattern to match Town standard. Paint all surfaces with bituminous coating.

Adjustment Brick: Concrete conforming to ASTM C 55, Grade S.

Drop Manholes: Construct with ductile-iron pipe as specified herein for water systems.

c. Pressure Sewers/Force Mains

Pipe shall be ductile iron or PVC conforming to the requirements for water mains of this specification.

d. Aggregates for Bedding and Backfill

Aggregates shall conform to the following sizes. Percentages passing are by weight.

Bank run gravel for trench backfill and foundation material:

<u>Sieve Size</u>	<u>Percent Passing</u>
2-1/2 square	100
1-4" square	25 min.
U.S. No. 200	10.0 max
Dust Ratio: <u>% Passing U.S. No. 200</u>	
<u>% Passing U.S. No. 40</u>	2/3 max.
Sand Equivalent	30 min.

Pipe Bedding for PVC Pipe

Sand

<u>Sieve Size</u>	<u>Percent Passing</u>
3/4"	100
3/8"	70-100
No. 4	55-100
No. 10	35 - 95
No. 20	20 - 80
No. 40	10-55
No. 100	0 - 10
No. 200	0 - 3

Pea Gravel

<u>Sieve Size</u>	<u>Percent Passing</u>
3/4"	100
3/8"	95 - 100
No. 8	0 - 10
No. 200	0 - 3

Pipe Bedding for ductile-iron pipe: Use bank run gravel.

e. Restoration Materials

Crushed surfacing for shoulders and pavement base:

<u>Sieve Size</u>	<u>Base Course</u>	<u>Top Course and Keystone</u>
	<u>Percent Passing</u>	
1-1/4" square	100	
5/8" square	50 - 80	100
1/4" square	30 - 50	55-75
U.S. No. 40	3 - 18	8 - 24
U.S. No. 200	7.5 max.	10.0 max.
% Fracture	75 min.	75 min.
Sand equivalent	40 min.	40 min.

Asphalt Concrete:

Class B per Section 5-04 of the Standard Specifications for Road, Bridge and Municipal Construction.

2. INSTALLATION

a. Trenching for Sewers and Water Mains

Trench width at top of pipe shall be minimum 30 inches and maximum 40 inches. At manhole excavations, provide 12-inch clearance around structure.

For trenches over 4 feet deep, provide shoring consistent with Washington State and Federal Safety codes.

Dewater trench and keep dry until backfill is placed and compacted.

Remove ledgerrock, boulders and stones to provide 6-inch minimum clearance around pipe.

When directed by the Town, overexcavate unsuitable material and remove from the site. Backfill with compacted bank run gravel to base of bedding line.

In easements or public rights of way outside of the developer's site, maximum open trench length is 200 feet.

Maintain excavated material so that there is minimum interference with public travel. Interrupt access to private driveway, fire hydrants, etc., only as necessary. Restore access as soon as possible. Provide one-day notice to residents of construction activity and blockage of property access.

b. Backfilling

Backfill with native material unless directed by the Town to use bank run gravel. Keep backfill free from debris and stones over 6 inches in length.

Place backfill in 8-inch lifts and mechanically compact with approved equipment. Compact to 95 percent maximum density in pavement areas and 90 percent in other areas. Densities will be determined by ASTM D 1557. In-place densities will be measured by ASTM D 1556 or ASTM D 2922.

In steep areas the Town may require clay trench dams to control groundwater flow along trench. Trench dams shall extend from the base of the bedding to 6 inches below grade.

c. Bedding

Bedding material for PVC sewer or water pipe shall conform to the specifications under Aggregates of this specification. Lay pipe on 4-inch layer of compacted bedding material. Continue backfilling with bedding material to 6 inches over the top of the pipe. Carefully place material around the pipe to provide full support and lateral restraint.

Ductile-iron pipe may be laid on the trench bottom unless bedding is required by the Town. Bedding shall be 4 inches under the pipe. Backfill with bedding material to the springline.

d. Water Main Installation

Pipe: Lay pipe with minimum 30-inch cover from finished grade unless plans require greater depth. Bed pipe as specified above.

Conform to AWWA Standard C600, the manufacturer's recommendations, and these specifications. Carry pipe. Do not roll or drag. Avoid damage to coatings, linings, and ends. Examine pipe for damage or defects before lowering into the trench. Cut pipe with

approved pipe saws only. Clean pipe of all foreign material before lowering into trench. Flushing capacity is limited and large particles must be kept out of the pipe.

All PVC pipe shall be laid with magnetic detector tape in the trench placed 18 inches below finished grade.

Provide water-tight plug for each size pipe installed. Plug pipe at end of each day's work. The Town will stop work whenever an approved pipe plug is not available at the job site.

Valve: Clean valve of all foreign material before installation. Provide blocking as required. Furnish valve box with all buried valves. Set box plumb, centered on valve, with top at grade. Install valve markers when directed. Paint marker and stencil valve distance on side facing valve.

Hydrants: Conform to AWWA Standard C600 and by the Standard Detail Fire Hydrant Assembly. Set hydrants to the grade indicated. Where necessary install barrel extensions to adjust the hydrant to the correct elevation. Paint shackle rods with one coat of red lead paint on a clean surface after installation. Holding spools or restrained mechanical joints may be used in lieu of shackle rods.

Concrete Blocking: Provide poured-in-place concrete blocking on fittings and angle points in the line. Keep concrete clear of bolts to permit dismantling the joint. Conform to size of block shown on the Water System Detail.

Connections to Existing Lines: Inform the Town two days prior to shutting off the line and proceed only after receiving permission. Assemble all necessary equipment and materials before breaking the lines and proceed continuously until connection is completed. Notify all affected users at least 24 hours in advance by a circular approved by the Town.

Service Lines: Conform to the Water System Details. Include curb stop immediately ahead of U-branch for double services or the meter box for single services. The meter will be installed later.

Concrete Guard Posts: Install where directed by the Town. Generally posts will not be used on hydrants where other protection such as curbs or ditches exist. Set posts 3-feet 0-inch to 3-feet 6-inches deep. Paint with two coats of approved concrete paint.

e. **Hydrostatic Pressure Test**

Apply hydrostatic pressure test to each valved section of the line as it is completed, unless otherwise allowed by the Town. The Contractor shall furnish all equipment including pressure gages and a flow meter to

record water loss. Test pressure shall be 150 psi over the system static pressure but not less than 200 psi. Include fire hydrants in the test. Pump the main back to the required pressure and measure the quantity of water used. For acceptance, the quantity of water lost from the main shall not exceed the number of gallons per hour determined by the formula:

$$L = \frac{NP(P)^{0.5}}{7,400}$$

in which:

L = Allowable leakage, gallons/hour

N = Number of joints in the length of pipeline tested

D = Nominal diameter of the pipe in inches

P = Average test pressure during the leakage test, psi.

f. Sterilization and Flushing

Conform to AWWA C651 using calcium hypochlorite granules. Chlorine residual shall be not less than 50 parts per million. Contact period minimum eight hours. Operate all valves while in contact with the chlorinating agent. Chlorine shall be introduced by the continuous feed method or by granular placement in each length of pipe.

Flush line after chlorination. Limit flushing rate until chlorine residual is normal to avoid contamination of water courses. Dechlorinate water prior to discharge if directed by the Town. Continue flushing at flow indicated. Inspect drainage system receiving water to avoid flooding or property damage.

The Town will take water samples for bacteriological test by the State Health Department. All portions of the system must have satisfactory test result before being accepted and placed in service.

g. Sewer Main Installation

Pipe: Lay pipe to the line and grade indicated on the plan profile. Grade control shall be by trench laser or by other method satisfactory to the Town. If laser control is not used, then control hubs at 25-foot intervals will be required.

Maximum deviation from profile grade is 0.03 feet, provided that no adverse pipe grade results.

Pipe jointing shall conform to manufacturer's specifications. Lubricants must be those supplied with the pipe for use with the gasket material.

Gaskets must be clean as joint is made. Plug open end of pipe when pipe laying is not in progress.

Manholes: Install in conformance with the Standard Detail. Place precast base on 6 inches of compacted pipe bedding material. Construct shelf and channel to the crown elevation of the pipes. Use 3,000 PS2 concrete. Make channel smooth with well rounded junctions with branch lines. Shelf must slope to drain to channel.

Adjust cover to grade with concrete bricks. Fill all joints with grout and seat casting in grout. Line and coat adjusting brick with 3/4-inch thick mortar for water tightness. Patch all lift holes in the wall for water tightness.

Side Sewers: Install side sewer in conformance with the Standard Detail. Bedding, backfilling and pipe laying shall conform to this specification.

h. Connections to Existing Sewer System

Connection to Existing Sewer Line: Where connection to the existing system is made between manholes, install a new standard manhole on the existing main. Service must be maintained for users above the connection. The channeling of the new manhole may be accomplished by cutting off the top half of the pipe through the manhole and constructing the channel around it. This method is subject to Town approval after examination of the existing pipe.

Connection to Existing Manholes. Where an existing manhole does not have an usable pipe stub for extension, make the connection by coring into the manhole wall not higher than 0.2 feet over the invert elevation. Breakout shelf as necessary to construct a smooth, well-rounded channel for the new connection. Keep the manhole in service and take precautions necessary to prevent debris from entering the existing sewer. Patch the manhole wall as directed by the Town.

i. Cleaning Sewer Lines

Clean all sewer lines in a manner acceptable to the Town. Methods may include flushing, rodding, or forcing an inflatable ball through the pipe. Remove all debris so that none is flushed into the existing sewer system.

j. Sewer Leakage Testing

Leakage testing shall be by air testing, infiltration testing or exfiltration testing. The Developer is responsible for determining the groundwater level to the Town's satisfaction. The selected test shall be conducted as follows:

- (1) Air Testing: Test pressure shall be 3.5 psi over the groundwater head at the mid point of the test section. The time for the pressure to drop 0.5 psi to 3.0 psi shall be greater than the following:

<u>Pipe Size</u>	<u>Seconds per Linear Foot of Pipe</u>
6-inch	0.25
8-inch	0.46
10-inch	0.72

- (2) Infiltration: This method is acceptable only when groundwater level is above the top of all pipe in the test section. Provide acceptable method of measuring infiltration flow. Test for one hour minimum. Maximum infiltration shall not exceed the following rates:

Allowable Leakage per 100 Feet of Pipe in Gallons/Hour

<u>Pipe Size</u>	<u>Groundwater Head Over Pipe at Upper End</u>				
	<u>2-ft</u>	<u>4-ft</u>	<u>6-ft</u>	<u>8-ft</u>	<u>11-ft</u>
6-inch	1.0	1.4	1.7	2.0	2.2
8-inch	1.3	1.8	2.2	2.6	2.9
10-inch	1.6	2.3	2.7	3.2	3.6

- (3) Exfiltration: Fill pipe to 6 feet over the crown of the pipe at the high end of the test section or to 6 feet over the groundwater level. Do not exceed 16 feet of head at the low end of the test section. Test for one hour minimum. Maximum exfiltration shall not exceed the following rates:

<u>Pipe Size</u>	<u>Exfiltration Rate Per 100 Feet of Pipe in Gallons/Hour</u>
6-inch	1.7
8-inch	2.2
10-inch	2.7

k. Restoration and Cleanup in Existing Public Rights of Way

Bituminous Pavement Replacement: Cut pavement with approved tools to even line. Minimum width of cut is 3 feet. Minimum pavement patch section is three inches of 3/4-inch minus crushed rock base and two inches of hot asphaltic concrete. Match existing section if depths are greater. Compact subgrade with tampers. Place and compact crushed rock base. Tack coat cut edge before patching. Roll asphaltic concrete in both directions with 5-ton roller and seal edges with hot asphalt cement.

Unpaved Roadway and Shoulders: Restore to original grades and ensure proper drainage. Place two-inch compacted layer of crushed surfacing top course where indicated. Town will check adequacy of shoulder grading prior to placement of crushed rock.

Lawn Restoration: Limit operations in lawn areas to avoid excessive damage. Place no pipeline materials or spoil pile on lawns. After pipe installation is complete bring the disturbed area to the proper grade and restore lawn by placing turf obtained from an approved source.

Street Cleaning: Wash and clean all streets of sand and debris caused by construction. Wash streets at end of each day's work when required by the Town to prevent dust nuisance. Provide water truck with pressure spray system designed for street cleaning when directed by Town.

Ditches and Culverts: Clean ditches of all foreign materials caused by construction. Keep culvert end free of debris at all times. Rake and smooth back slopes disturbed by construction. Remove all debris including large rocks.



TOWN OF FRIDAY HARBOR
Post Office Box 219 • Friday Harbor, Washington 98250
(360) 378-2810 • FAX: (360) 378-5339 • www.fridayharbor.org

RECOMMENDED METHOD FOR WATER MAIN TESTING & DISINFECTION*

1. Use blind plate and FL x MF fitting to connect new work to new or existing valve.
2. Use tablets with gasket glue to supply chlorine to pipe during construction (conform to AWWA C651 - Tablet Method).
3. Fill pipe slowly via approved double back flow prevention device. Bleed air out at services and other appropriate points.
4. Pressure test against blind flange. Include all services laterals in the test.
5. Take chlorine residual reading after a minimum of 24 hours has passed. Residual must be at least 25 ppm anywhere in the new piping. If residual is too low or leaks and repairs cause loss of test water then the continuous feed method should be used. Refer to AWWA C651, Continuous - Feed Method. Initial chlorine concentration shall be at least 25 ppm.
6. Flush using approved backflow prevention device. Direct heavily chlorinated water into tank (haul to approved disposal site) or use approved de-chlorinator.
7. Remove blind plate and request Town to open main valve for high velocity flush.
8. Take bacteriological sample and send to lab for analysis. Close valve after sample is taken.
9. Submit test results to engineer. Town will certify new main after satisfactory bacteriological test.

* Testing must conform to AWWA minimum requirements. Reference C-605 and C-651.

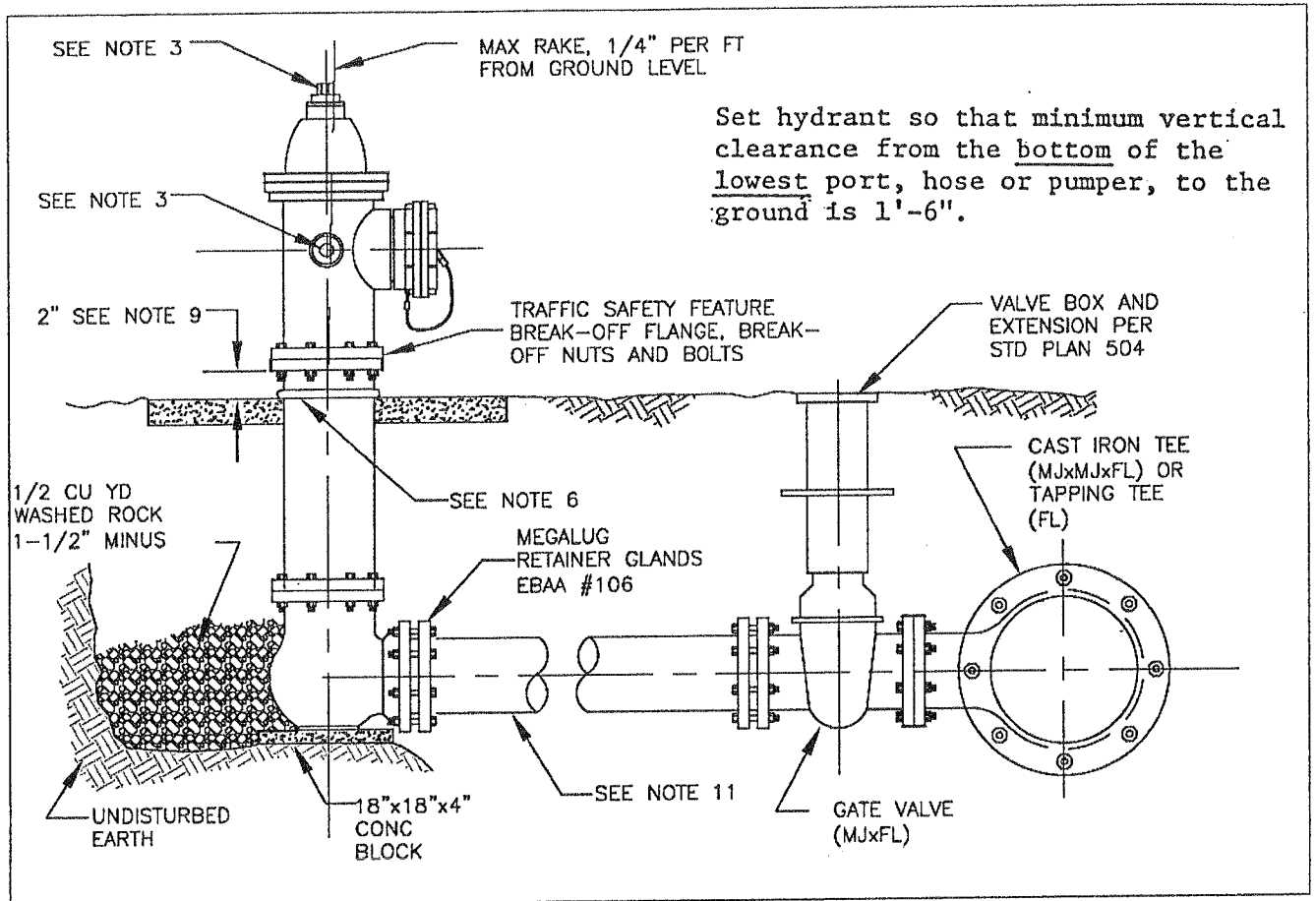

FIRE HYDRANT ASSEMBLY

notes

1. HYDRANTS AND ALL MATERIALS SHALL CONFORM TO AWWA STANDARDS AND SHALL BE OF STANDARD MANUFACTURE (WATEROUS PACER, OR APPROVED EQUAL)
2. 5 1/4" VALVE MINIMUM
3. 1 1/4" OPERATING NUT AND CAP NUT FOR 2 1/2" PORTS
4. NATIONAL STANDARD THREAD ON THE 5 1/4" PORT
5. PROVIDE VEHICULAR TRAFFIC PROTECTION WHEN NECESSARY PER STD.
6. IF HYDRANT RISES THROUGH CONCRETE, USE EXPANSION STRIP AROUND HYDRANT BARREL. IN ADDITION, INSTALLATION OF THE HYDRANT ON PRIVATE PROPERTY SHALL EQUAL OR EXCEED THE STANDARDS FOR INSTALLATION OF PUBLIC FIRE HYDRANTS IN THE TOWN OF FRIDAY HARBOR.
7. STEAMER PORT TO BE FACING STREET OR ROADWAY FOR FIRE ENGINE ACCESS.
8. HYDRANT SHALL BE CLEAR OF ALL DEBRIS SUCH AS ROCKS, MUD ETC.
9. BREAK OFF FLANGE TO BE 2" ABOVE GROUND LEVEL.
10. FIRE HYDRANTS SHALL BE PAINTED WITH TWO COATS OF HIGH GLOSS SAFETY YELLOW "RUST-OLEM TYPE PAINT"
11. HYDRANT CONNECTION PIPE TO BE DUCTILE IRON CLASS 52, ANY INTERMEDIATE JOINTS TO BE MJ WITH RETAINER GLANDS, OR FIELD LOCK GASKET

TOWN OF FRIDAY HARBOR WATER DEPARTMENT

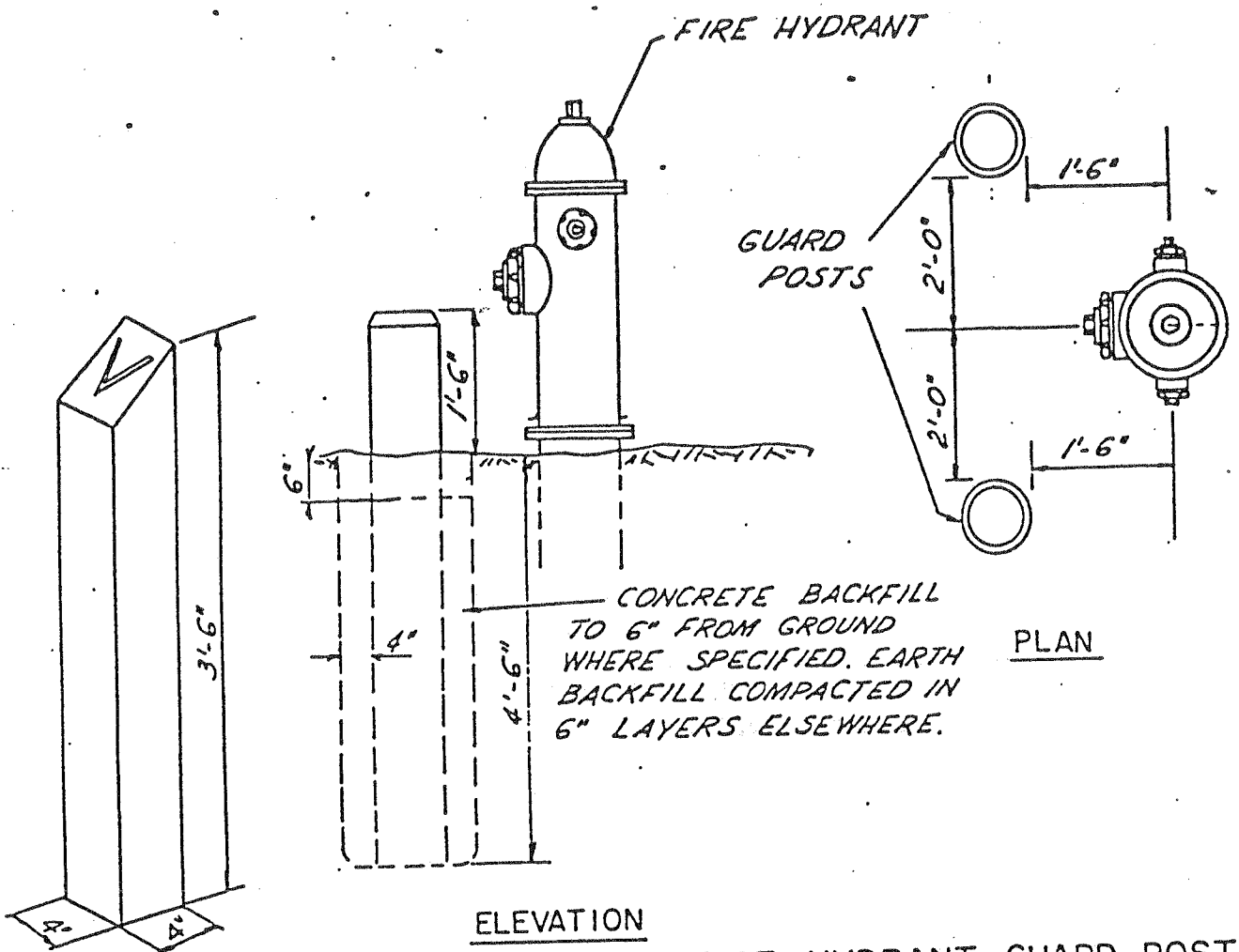

VALVE
MARKER POST

ELEVATION

FIRE HYDRANT GUARD POST

DO NOT USE WITH CURB SECTION

Notes:

1. Guard Posts shall be 9" diam. x 6' long precast concrete posts per Department of Highways "STANDARD SPECIFICATIONS", 1963, Section 72.02 B. Paint with two (2) coats of Inertol Ramuc masonry paint,
2. Valve marker post shall be equal to Greystone PC 3.05. Paint as specified for hydrant guard post. Paint distance from the valve marker to the valve on the post with black enamel paint.

STANDARD DETAIL
 FIRE HYDRANT GUARD POST
 AND VALVE MARKER POST
 BY CA CHK M.T. DATE June 1976
 SCALE None SHEET 1 OF 1

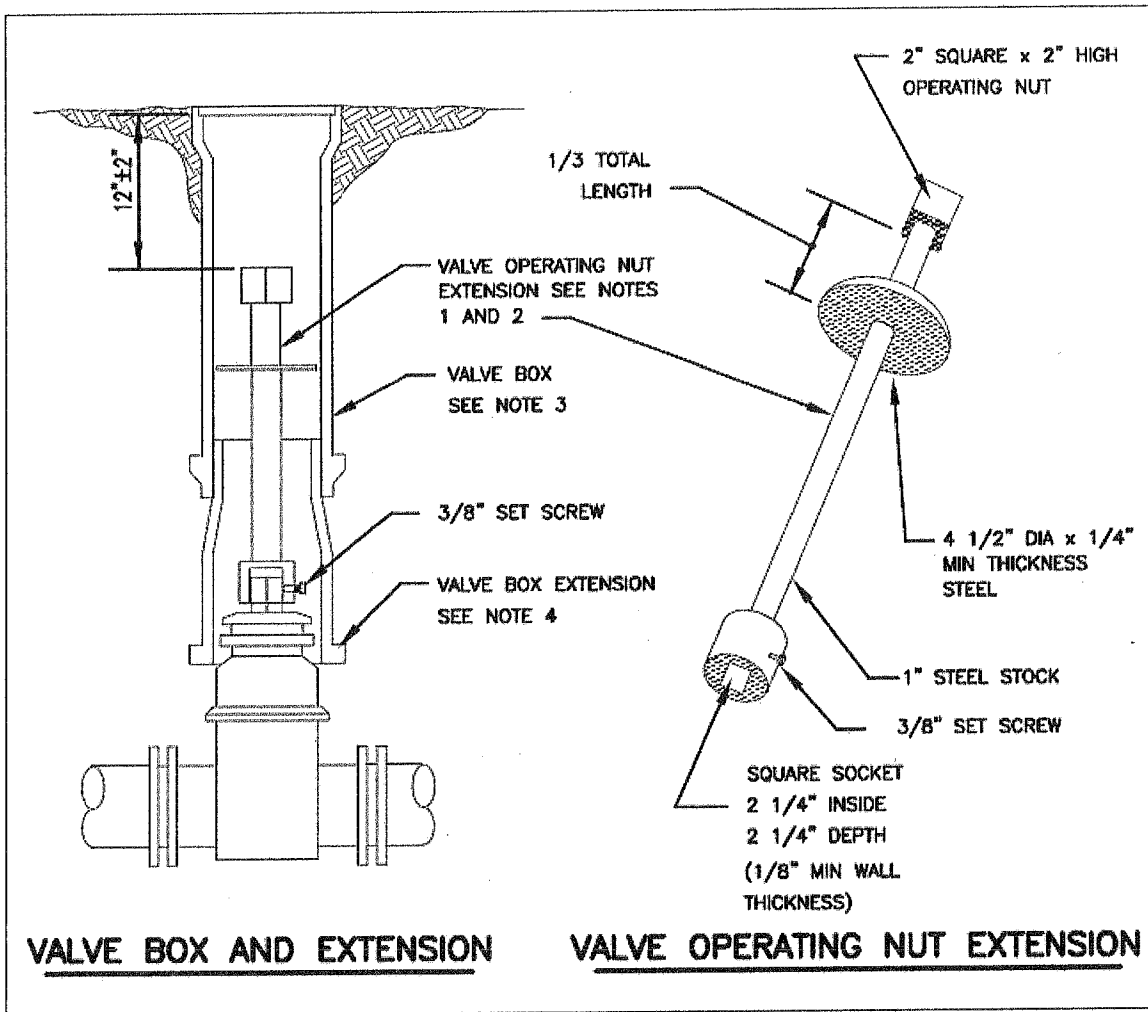

WATER BOX AND EXTENSION

NOTES

1. VALVE OPERATING NUT EXTENSIONS ARE REQUIRED WHEN THE NUT IS MORE THAN TWO FEET BELOW FINISHED GRADE. EXTENSIONS ARE TO BE A MINIMUM OF ONE FOOT LONG. ONLY ONE EXTENSION WILL BE ALLOWED PER VALVE.
2. ALL OPERATING NUT EXTENSIONS ARE TO MADE OF STEEL, SIZED AS NOTED, AND PAINTED WITH TWO COATS OF METAL PAINT.
3. VALVE BOXES IN PAVED AREAS SHALL BE CAST IRON. TWO PIECE UNITS WITH (LUGS) ON COVER.EQUAL TO "RICH NUMBER 940" AS MANUFACTURED BY RICH OR SATHER. IN GRASS NON-PAVED OR NON-TRAFFIC AREAS USE OF PLASTIC VALVE BOXES, WITH CAST IRON LIDS AS MANUFACTURED BY HANDLEY INDUSTRIES ARE ACCEPTABLE.
4. USE OF PLASTIC VALVE BOX EXTENSIONS, AS MANUFACTURED BY HANDLEY INDUSTRIES ARE ACCEPTABLE.

TOWN OF FRIDAY HARBOR WATER DEPARTMENT

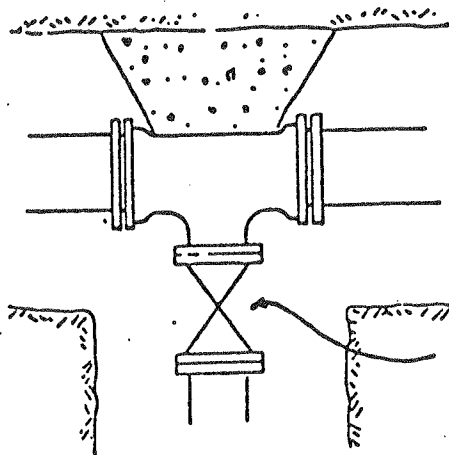

TYPICAL FLANGE VALVES TO TEE

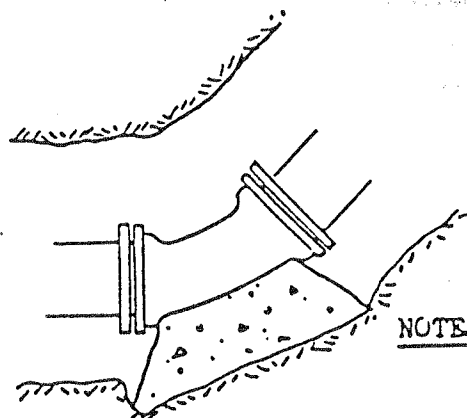
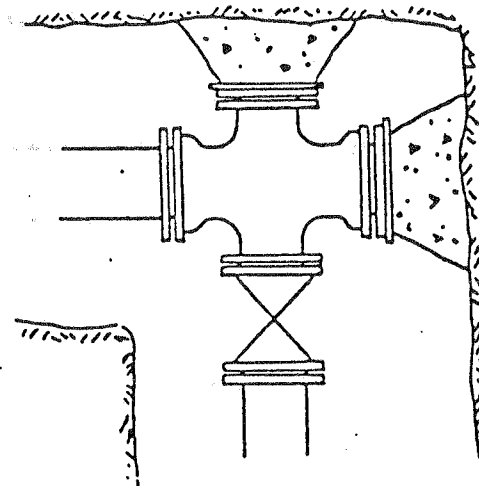
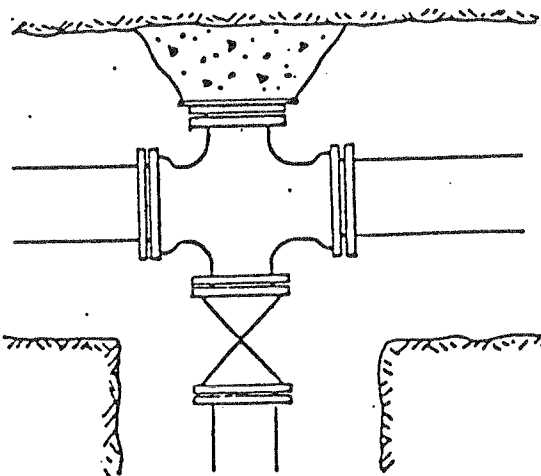
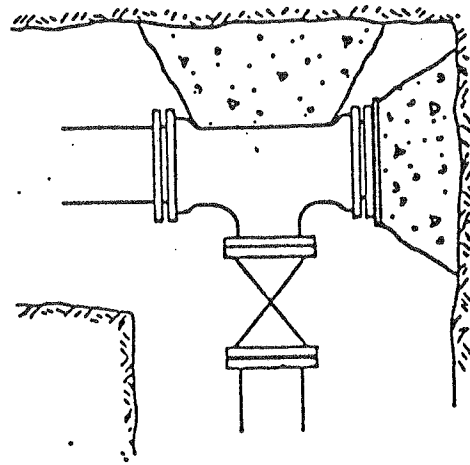

FITTING SIZES	BEARING AREA OF BLOCK IN SQ. FT.			
	TEES & ENDS	90 BEND	45 BEND	22½ BEND
4	1½	2	1½	1½
6	3	4	2	1½
8	4½	7	3½	2
10	7½	10½	5	3
12	10½	15	8	4

NOTES

1. All blocking shall be poured against firm undisturbed soil.
2. Bearing area at fittings not given in bearing table shall be as directed by the Engineer.
3. When pouring against plugs and blind flanges set steel meter box lid against fitting to keep concrete off bolts.
4. Layout to be approved by Engineer prior to concrete pour.

STANDARD DETAIL
 CONCRETE BLOCKING
 & VALVE LOCATION
 BY CA CHK M.T. DATE June 1976
 SCALE None SHEET 1 OF 1

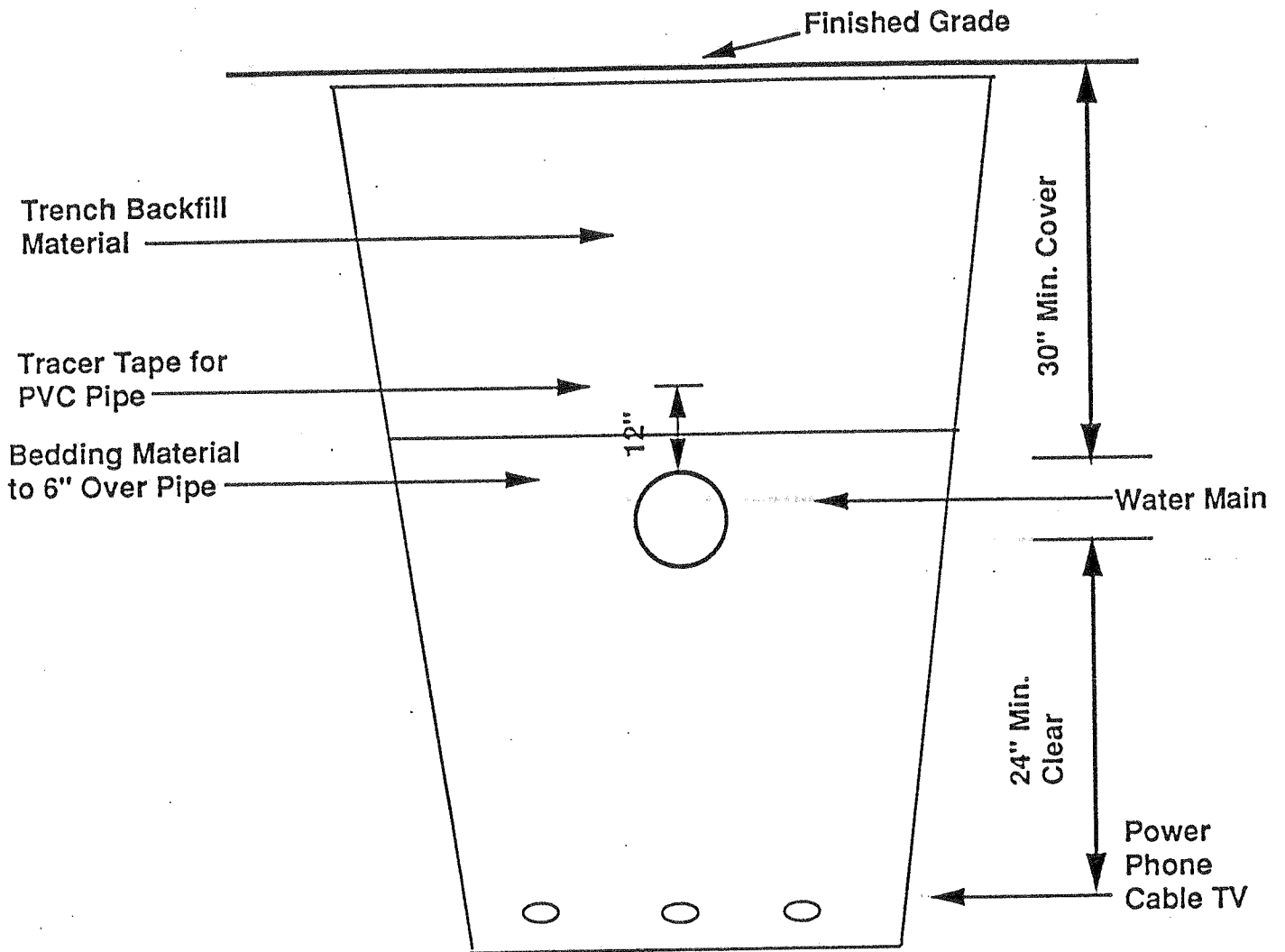

**TRENCH SECTION FOR
COMMON USE OF WATER MAIN
AND OTHER UTILITIES**

**TOWN OF FRIDAY HARBOR
WATER STANDARD DETAIL**

LEGEND

SERVICE/SECONDARY LINES

- 1 - 1/2" TELEPHONE SVC CONDUIT
- 1 - 1/2" CATV SVC CONDUIT
- 3/4" WATER PIPE
- 2" POWER CONDUIT

EQUIPMENT

-  WATER METER
-  TELEPHONE PEDESTAL
-  CATV PEDESTAL

POWER TRANSFORMER VAULT (UM3-41)

10 FT GRND ROD

GROUND WIRE

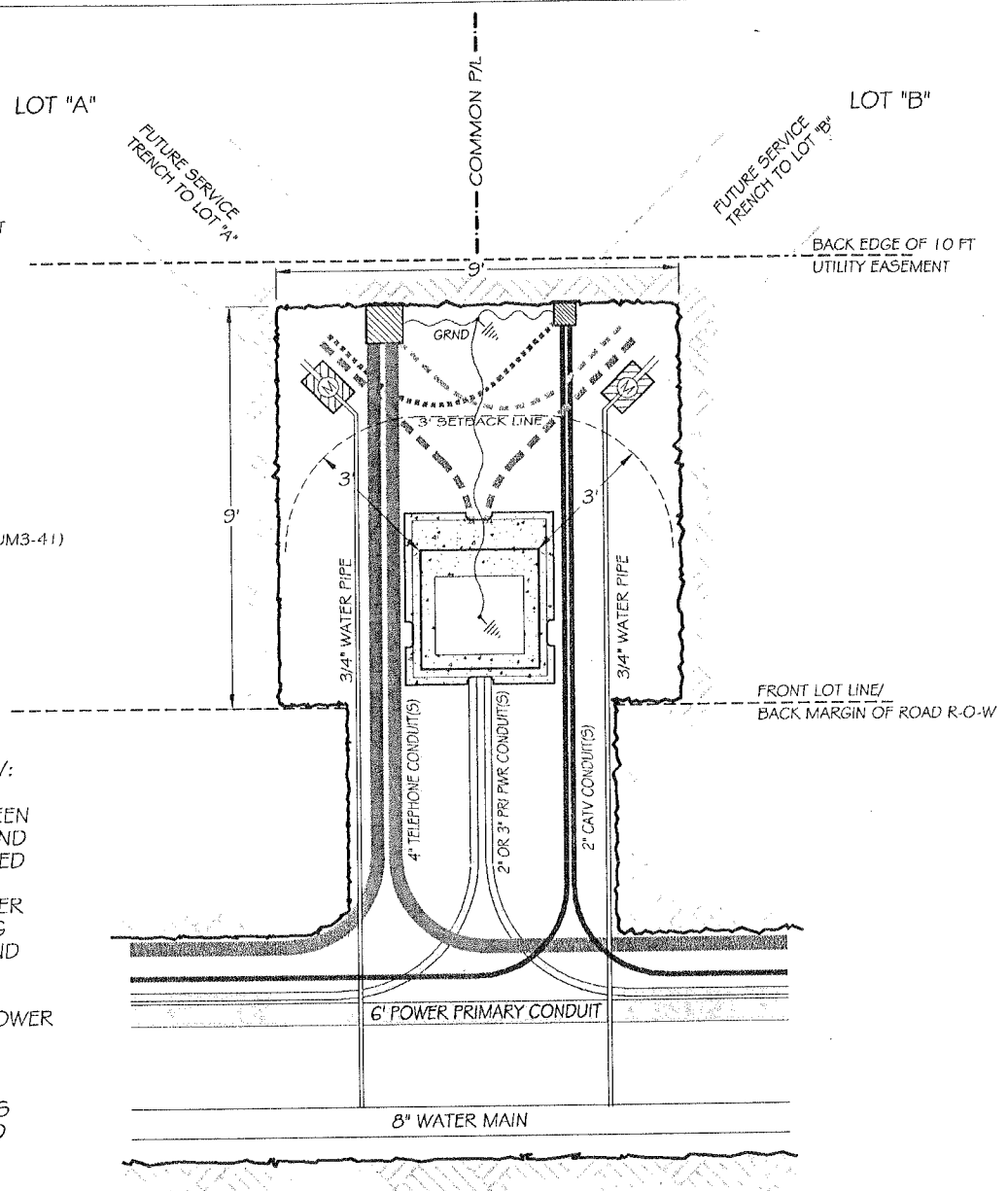
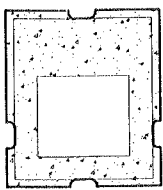

NOTES FOR EXCAVATION PLAN VIEW:

1) BONDING SHALL BE PROVIDED BETWEEN ALL ABOVE GROUND METALIC POWER AND COMMUNICATION APPARATUS SEPERATED BY 6 FEET OR LESS. OPALCO TO PROVIDE/INSTALL GROUND RODS. OTHER UTILITIES TO PROVIDE/ENSURE BONDING GROUND WIRE BETWEEN APPARATUS AND GROUND RODS.

2) PROVIDE 3' SEPERATION BETWEEN POWER TRANSFORMER AND ALL OTHER ABOVE GROUND APPARATUS

3) INSTALL/PROVIDE SERVICE GETAWAYS FOR ALL UTILITIES AS SHOWN TO AVOID RE-DIG OVER INSTALLED PRIMARY AND SECONDARY FACILITIES

UTILITY LAYOUT PLAN VIEW
SMALL LOT SUBDIVISION SPEC

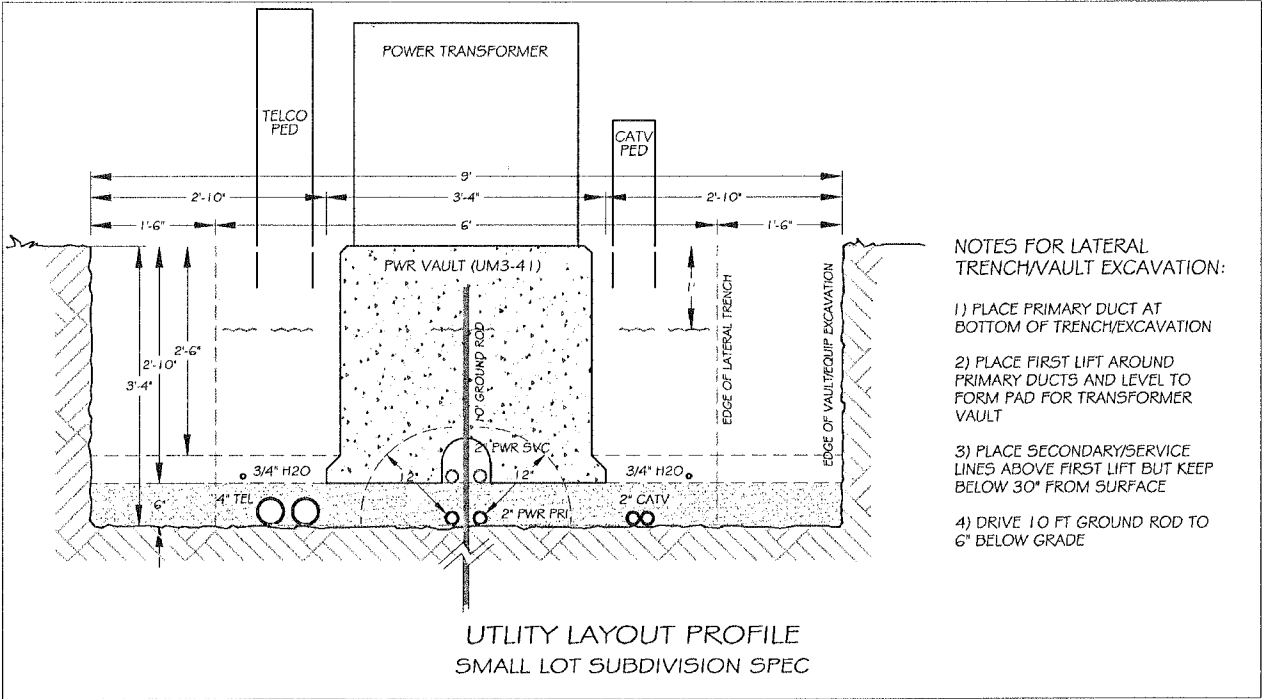
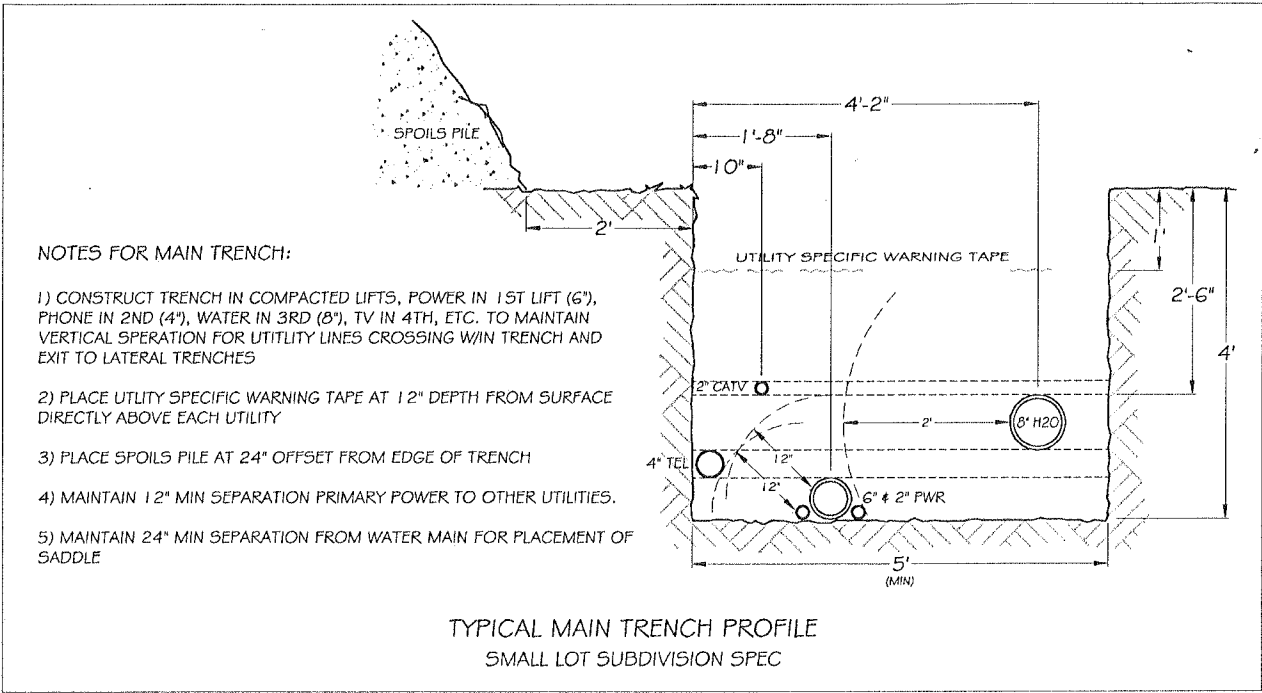

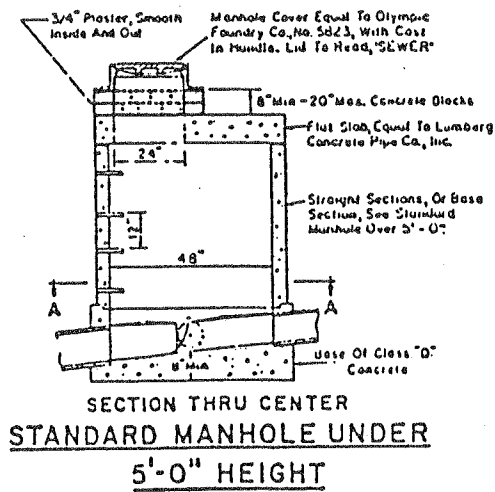

SECTION THRU CENTER
STANDARD MANHOLE UNDER
5'-0" HEIGHT

NOTE:
MANHOLES LOCATED WITHIN
EASEMENTS SHALL HAVE LOCK-
ING TYPE MANHOLE COVERS.
ATLAS FOUNDRY 'KAM-LOCK' NO.
2191 KL OR EQUAL.

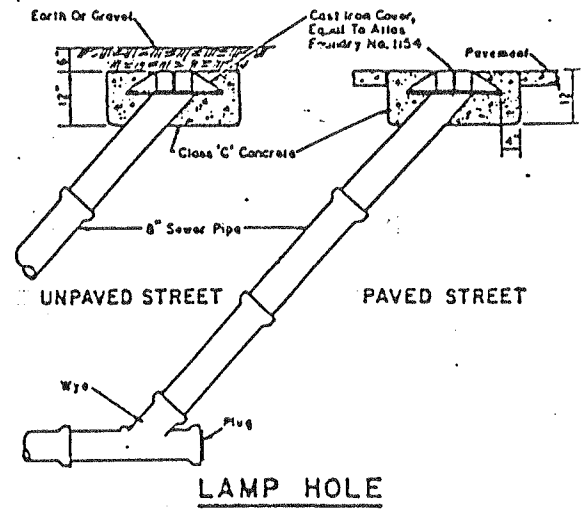

LAMP HOLE

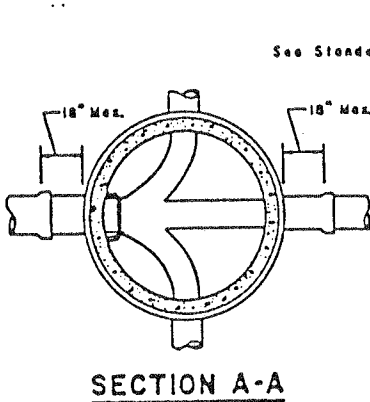

SECTION A-A

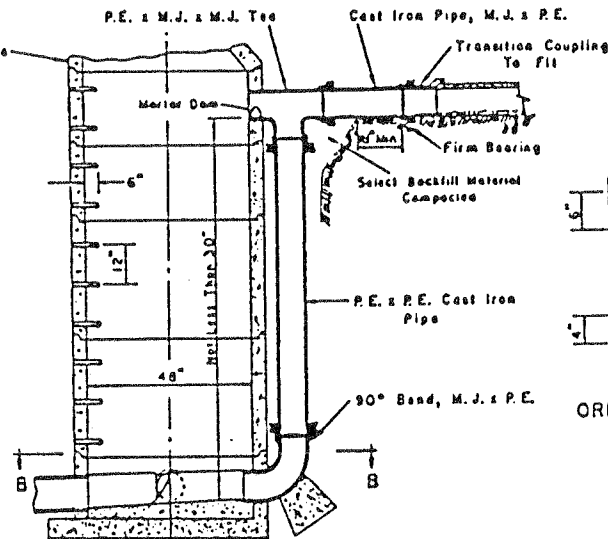

SECTION THRU CENTER
DROP MANHOLE

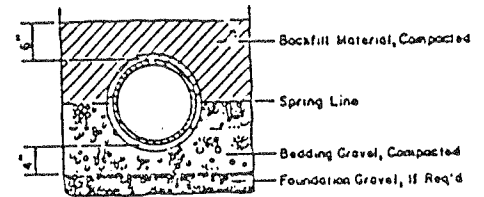

ORDINARY PIPE BEDDING

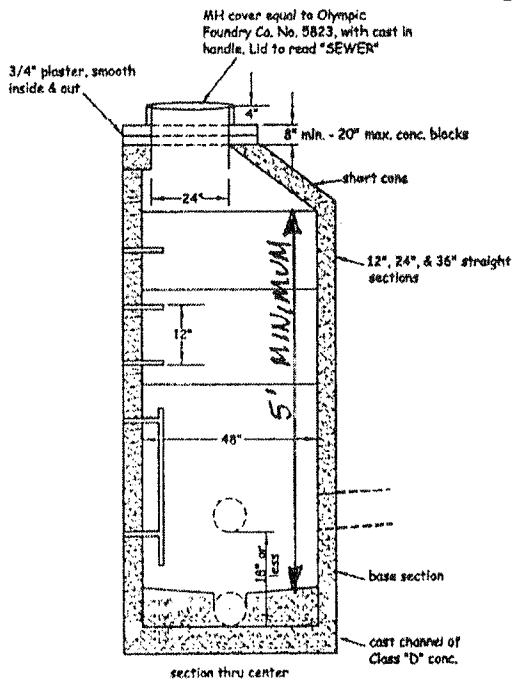

SECTION THRU CENTER
STANDARD MANHOLE OVER 5' - 0" HEIGHT

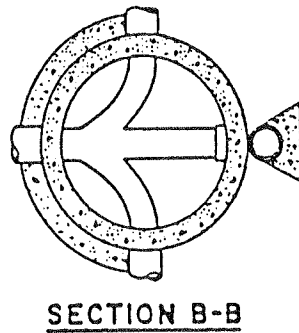

SECTION B-B

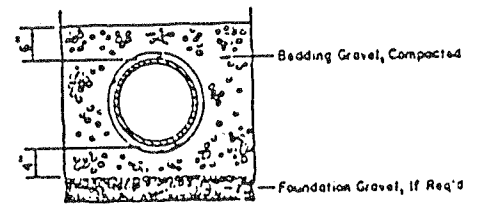

SPECIAL PIPE BEDDING

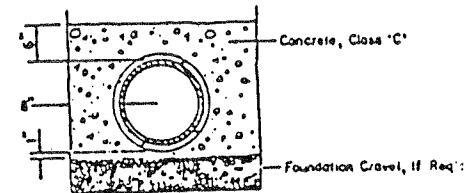

CONCRETE ENCASEMENT

PRECAST SECTIONS SHALL BE REINFORCED PER A.S.T.M. SPECS. FOR CORRESPONDING SIZE SEWER PIPE.

GALVANIZED DEFORMED BAR STEPS, 3/4" MINIMUM.

STEPS IN PRECAST BASE SECTION MAY BE CAST IN PLACE, OR MOVABLE SAFETY LADDER GROUTED IN PLACE.

ALL HOLES FOR PIPE SHALL BE BLOCKED OUT AT THE TIME OF CASTING THE SECTION.

PIPE BEDDING CLASSES

SEWER GENERAL STANDARD DETAILS

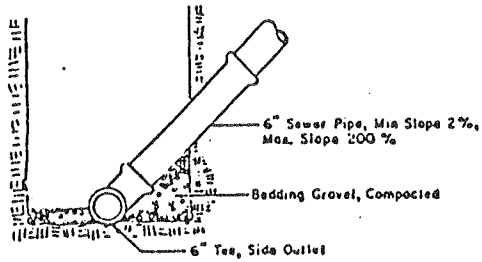

CONNECTION AT SEWER MAIN

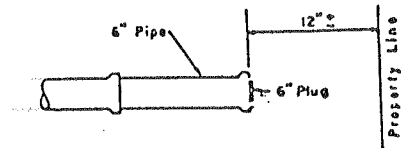

SINGLE SERVICE

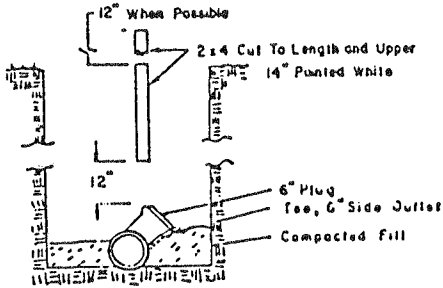

PLUGGED TEE ON SEWER MAIN

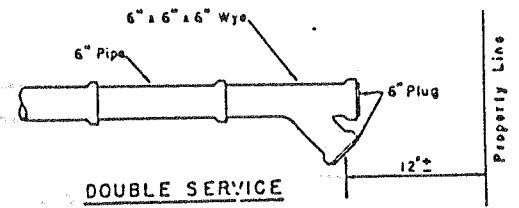

DOUBLE SERVICE

NOTES

1. WHERE SIDE SEWER CONNECTS TO MANHOLE INVERT OF SIDE SEWER SHALL BE EQUAL TO OR ABOVE MAIN SEWER CROWN, BUT NOT TO EXCEED 18" ABOVE INVERT OF MAIN SEWER.
2. UNLESS OTHERWISE INDICATED ON PLAN, SIDE SEWER SHALL BE MINIMUM OF FIVE (5) FEET DEEP AT PROPERTY LINE, OR 4.5 FEET LOWER THAN THE LOWEST HOUSE ELEVATION, WHICH EVER IS LOWER.

SIDE SEWER

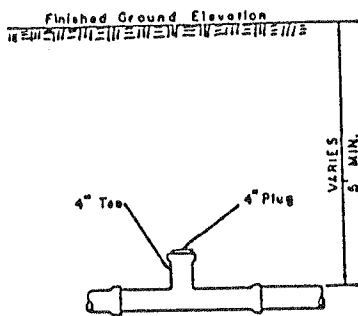

TESTING TEE

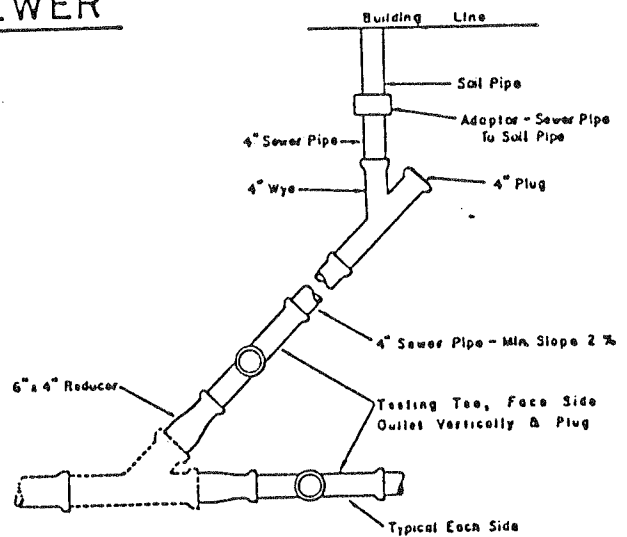

BUILDING CONNECTION

HOUSE SEWER

SECTION F
ATTACHMENTS

Easement Form

Bill of Sale - Water System

Bill of Sale - Sewer System

Performance Bond

Water and/or Sewer Facility Contract

EASEMENT

THIS INSTRUMENT made this _____ day of _____, _____,
by and between _____
and _____

hereinafter called "Grantors", and TOWN OF FRIDAY HARBOR, a municipal corporation of San Juan County, State of Washington, hereinafter called "Grantee":

WITNESSETH:

That said Grantors for and in consideration of the mutual benefit of the parties, do by these presents grant, bargain, sell, convey, and confirm unto the said Grantee a right of way or easement for _____

with necessary appurtenances over, through, across and upon the following described property situated in San Juan County, Washington, more particularly described as follows:

The said Grantee shall have the right without prior institution of suit or proceeding of law, at times as may be necessary, to enter upon said property for the purpose of constructing, repairing, altering, or reconstructing said _____

or making any connections therewith, without incurring any legal obligation or liability therefore; provided that such constructing, repairing, altering, or reconstructing of said _____

shall be accomplished in such a manner that the private improvements existing in this right of way shall not be disturbed or destroyed, or in the event that they are disturbed or destroyed,

BILL OF SALE

**WATER SYSTEM
TOWN OF FRIDAY HARBOR**

San Juan County, Washington

KNOW ALL MEN BY THESE PRESENTS, that for and in consideration of the mutual benefit of the parties; _____, Grantor, does hereby grant, bargain, and sell to the TOWN OF FRIDAY HARBOR, San Juan County, Washington, Grantee, the following described improvements situated in San Juan County, Washington:

A domestic water system consisting of:

WATER MAINS

<u>LOCATION</u>	<u>FROM</u>	<u>TO</u>	<u>SIZE</u>
-----------------	-------------	-----------	-------------

Including approximately _____ lineal feet of _____ pipe, _____ hydrants, _____ valves, and all appurtenances, to have and to hold the same to the said Grantee, its successors, and assigns forever.

The undersigned hereby covenants that it is the lawful owner of said property; that the same is free from all encumbrances; that all bills for labor and material have been paid; that it has the right to sell the same as aforesaid, that it will warrant and defend the same against the lawful claims and demands of all persons holding Grantee harmless from all claims.

This Bill of Sale is given in consideration of the agreement of the Grantee, for itself, its successors and assigns to incorporate said domestic water system into its utility system and to maintain them as provided in the applicable Town ordinances.

IN WITNESS WHEREOF, the undersigned has caused this instrument to be executed by its proper officers, who are duly authorized, on this _____ day of _____ 2 _____.

Title _____

Title _____

STATE OF WASHINGTON)
)
COUNTY OF SAN JUAN

On _____ day of _____, 2 _____, personally appeared before me _____ and _____, who is/are personally known to me or whose identity I proved to be the signer(s) of the above instrument, and he/she acknowledged that he/she signed it.

Notary Public
My commission expires _____

This Bill of Sale is given and accepted pursuant to Resolution No. _____ of the Town of Friday Harbor, San Juan County, Washington.

BILL OF SALE

**SEWER SYSTEM
TOWN OF FRIDAY HARBOR**

San Juan County, Washington

KNOW ALL MEN BY THESE PRESENTS, that for and in consideration of the mutual benefit of the parties; _____, Grantor, does hereby grant, bargain, and sell to the TOWN OF FRIDAY HARBOR, San Juan County Washington, Grantee, the following described improvements situated in San Juan County, Washington:

A sanitary sewer system consisting of:

SEWER MAINS

<u>LOCATION</u>	<u>FROM</u>	<u>TO</u>	<u>SIZE</u>
-----------------	-------------	-----------	-------------

Including approximately _____ lineal feet of _____ pipe, _____ manholes, and all appurtenances, to have and to hold the same to the said Grantee, its successors, and assigns forever.

The undersigned hereby covenants that it is the lawful owner of said property; that the same is free from all encumbrances; that all bills for labor and material have been paid; that it has the right to sell the same as aforesaid, that it will warrant and defend the same against the lawful claims and demands of all persons holding Grantee harmless from all claims.

This Bill of Sale is given in consideration of the agreement of the Grantee, for itself, its successors and assigns to incorporate said sanitary sewer system into its utility system and to maintain them as provided in the applicable Town ordinances.

IN WITNESS WHEREOF, the undersigned has caused this instrument to be executed by its proper officers, who are duly authorized, on this _____ day of _____ 2_____.

Title _____

Title _____

STATE OF WASHINGTON)
)
COUNTY OF SAN JUAN

On _____ day of _____, 2_____, personally appeared before me _____ and _____, who is/are personally known to me or whose identity I proved to be the signer(s) of the above instrument, and he/she acknowledged that he/she signed it.

Notary Public
My commission expires _____

This Bill of Sale is given and accepted pursuant to Resolution No. _____ of the Town of Friday Harbor, San Juan County, Washington.

BILL OF SALE

**STORM SEWER SYSTEM
TOWN OF FRIDAY HARBOR**

San Juan County, Washington

KNOW ALL MEN BY THESE PRESENTS, that for and in consideration of the mutual benefit of the parties; _____, Grantor, does hereby grant, bargain, and sell to the TOWN OF FRIDAY HARBOR, San Juan County Washington, Grantee, the following described improvements situated in San Juan County, Washington:

A storm sewer system consisting of:

STORM SEWER MAINS

<u>LOCATION</u>	<u>FROM</u>	<u>TO</u>	<u>SIZE</u>
-----------------	-------------	-----------	-------------

Including approximately _____ lineal feet of _____ pipe, _____ catch basins, _____ manholes, and all appurtenances, to have and to hold the same to the said Grantee, its successors, and assigns forever.

The undersigned hereby covenants that it is the lawful owner of said property; that the same is free from all encumbrances; that all bills for labor and material have been paid; that it has the right to sell the same as aforesaid, that it will warrant and defend the same against the lawful claims and demands of all persons holding Grantee harmless from all claims.

This Bill of Sale is given in consideration of the agreement of the Grantee, for itself, its successors and assigns to incorporate said storm sewer system into its utility system and to maintain them as provided in the applicable Town ordinances.

IN WITNESS WHEREOF, the undersigned has caused this instrument to be executed by its proper officers, who are duly authorized, on this _____ day of _____, 2_____.

Title _____

Title _____

STATE OF WASHINGTON)
)
COUNTY OF SAN JUAN

On _____ day of _____, 2_____, personally appeared before me _____ and _____, who is/are personally known to me or whose identity I proved to be the signer(s) of the above instrument, and he/she acknowledged that he/she signed it.

Notary Public
My commission expires _____

This Bill of Sale is given and accepted pursuant to Resolution No. _____ of the Town of Friday Harbor, San Juan County, Washington.